

2162L

SINGLE POINT LOAD CELLS "OFF CENTER"

Economical single point load cells specially designed for small platform and hopper weighing.



Model 2162L - 10 kg



Features

- o Designed for off-center load
- o Maximum platform size: 400 x 400 mm
- o Material: anodised aluminium alloy
- o Protection class: IP63
- o Competitive price
- o Easy to install
- o Weight: 0.35 kg
- o Cable length: 2 m (other lengths available on request)

Most popular options



Ex i



Application(s) SENSY's load cells 2162L are perfectly designed for the following applications:

- Single point load cells for industrial scales and weighing systems,
- Small hopper weighing,
- Filling, packaging and batching applications.

Capacities

2162L: 10 - 15 - 20 - (30) - 50 - 75 kg

Specifications

Specifications	A3	
Accuracy class	0.03 %** F.S.*	-
Combined error (non-linearity + hysteresis)	<± 0.03	% F.S.*
Repeatability error	<± 0.015	% F.S.*
Creep error over 30 min.	<± 0.03	% F.S.*
Reference temperature	23	°C
Compensated temperature range	-10...+45	°C
Service temperature range	-30...+70	°C
Storage temperature range	-50...+85	°C
Temperature coefficient of the sensitivity	< ± 0.1	% F.S./10°C
Temperature coefficient of zero signal	< ± 0.05	% F.S./10°C
Zero balance	± 0.02	mV/V
Nominal sensitivity	2 ± 10%	mV/V
Sensitivity tolerance	<± 0.2	%
Input resistance	350 ± 2	ohm(s)
Output resistance	350 ± 2	ohm(s)
Insulation resistance (50 V)	> 5000	Mohm(s)
Reference excitation voltage	10	VDC
Permissible nominal range of excitation voltage	3..12	VDC
Safe load limit	150	% F.S.*
Breaking load	>300	% F.S.*
Permissible dynamic loading	60	% F.S.*
Static lateral force limit	100	% F.S.*

* F.S. : Full Scale.

** : except thermal drifts.

Specifications subject to change without notice.



ISO 9001 certified

2162L > STANDARD DIMENSIONS

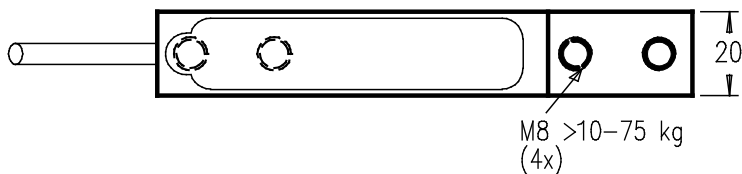
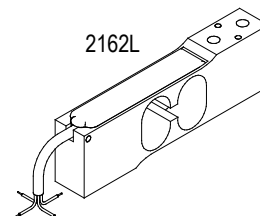
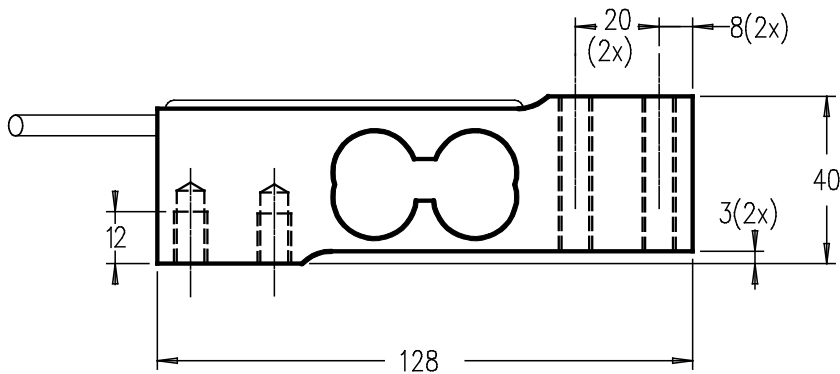

Note: correct torque for fixing bolts: 10 N·m if M8; 50 N·m if M10 (do not touch bottom of tapped holes)

Ref. Item	Capacities	Weight (kg)	Note
2162L-A	10 - 75 kg	0.35	-
2162L-Ex-A	10 - 75 kg	0.35	Cover and cable gland mandatory for Ex i version

Other capacities and dimensions available on request

Dimensions in mm

Accessories

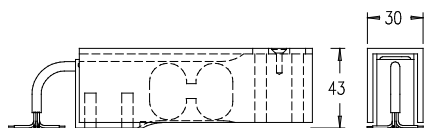

F- COVER OPTION

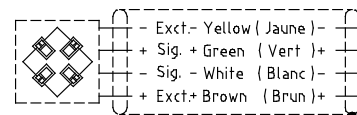
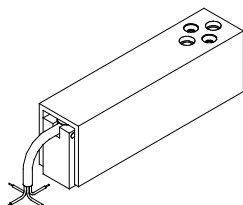

Standard : Cable screen not connected to transducer
Faradisation non connectée au capteur

Load direction

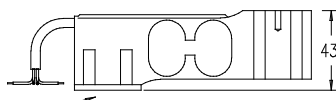
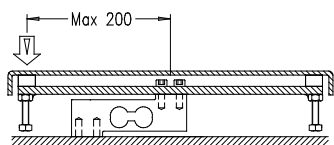

Polyethylene plate

Sales rep.:



Sensors AS
Setersletta 3
NO-2006 LØVENSTAD

+47 67 90 43 00
post@sensors.no
www.sensors.no